

B773 · B774 · B7740  
SINGLE NEEDLE ADJUSTABLE TOP AND  
BOTTOM FEED LOCK STITCH MACHINE  
(PLY SENSOR)





## GAUGE PARTS LIST





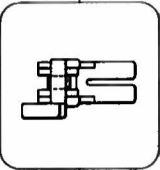
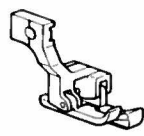
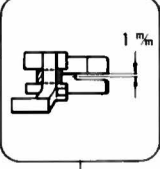
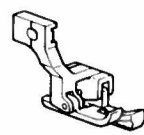
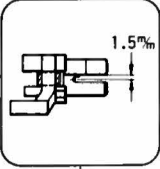

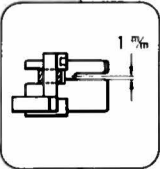
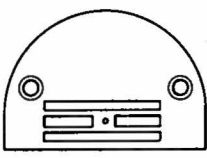
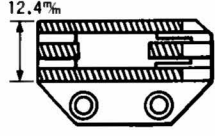
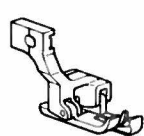
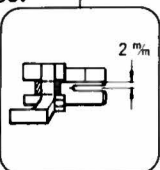

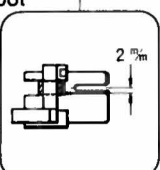

## CONTENTS

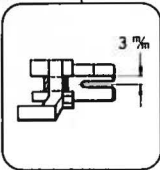
1. For Topstitching .....	1
2. For Gathering .....	6
3. For Rolled-Hemming .....	6
4. For Materials Hard to Feed .....	7
5. For Sewing Zipper (Exclusive Right) .....	8
6. For Sewing Zipper (Exclusive Left) .....	9
7. For Binding .....	9
8. For Restrain Cloth from Flapping .....	10
9. Effective Type for Packerling .....	10
10. For Piping .....	10
11. For Concealed-Seaming Waist Belt .....	11
12. For Special Type .....	11
13. For B7740, 25 m/m Sensor .....	12
14. For B7740, 18 m/m Sensor .....	14

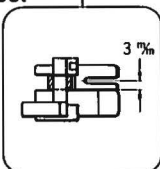
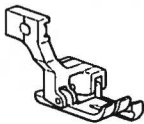
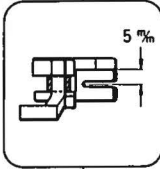
# ●ステッチ縫い用

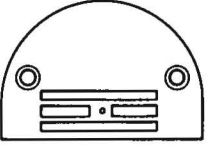
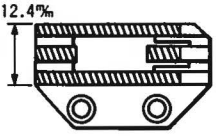
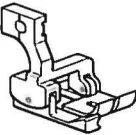
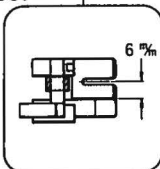

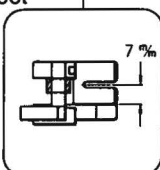

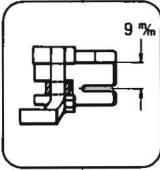





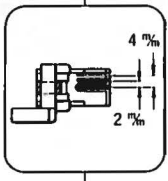
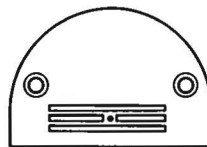
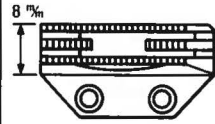

Gauge Type	Presser Foot Assembly	Upper Feed Dog	Needle Plate	Feed Dog	Uses
A	Free presser foot  151277-101	Oblique type teeth 	$\phi 1.6$	Oblique type teeth P 1.15	Men's and lady's wear etc. Stitching sleeve caps, Basting under sleeve, Seaming back center, Joining shoulders, Sewing sides
AC 1	Free presser foot  159447-101	 1 mm			Dress, Shirt, Blouse etc. Topstitching edge, Sewing pocket (1 mm compensating foot)
AC 1.5	Free presser foot  S 13745-001	 1.5 mm			Dress, Shirt, Blouse etc. Topstitching edge, Sewing pocket (1.5 mm Right compensating foot)
ACL 1	Free presser foot  S 14317-001	 1 mm		 12.4 mm	Dress, Shirt, Blouse etc. Topstitching edge, Sewing pocket (1 mm Left compensating foot)
AC 2	Free presser foot  S 01041-101	 2 mm			Dress, Shirt, Blouse etc. Topstitching edge, Sewing pocket (2 mm Left compensating foot)
ACL 2	Free presser foot  S 14321-001	 2 mm	S 13256-001	159288-001	Dress, Shirt, Blouse etc. Topstitching edge, Sewing pocket (2 mm Left compensating foot)
			159288-001	159301-001	

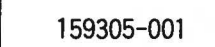
# ● For Topstitching

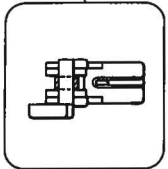

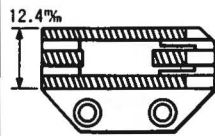
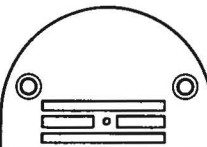

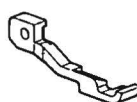
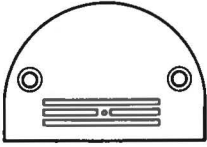
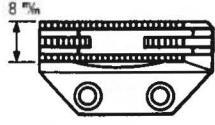
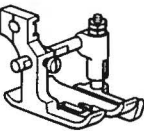
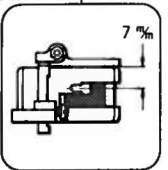



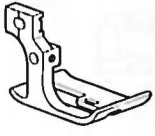

Gauge Type	Presser Foot Assembly	Upper Feed Dog	Needle Plate	Feed Dog	Uses
A C 3	Free presser foot  S 01044-101	Oblique type teeth 	$\phi 1.6$	Oblique type teeth P 1.15	Dress, Shirt, Blouse etc. Topstitching edge, Sewing pocket (2 mm Left compensating foot)
A C L 3	Free presser foot  S 14323-001				Dress, Shirt, Blouse etc. Topstitching edge, Sewing pocket (3 mm Left compensating foot)
A C 5	Free presser foot  S 13748-001	 			Dress, Shirt, Blouse etc. Topstitching (5 mm Right compensating foot)
A C L 6	Free presser foot  S 13754-001				Dress, Shirt, Blouse etc. Topstitching (6 mm Left compensating foot)
A C L 7	Free presser foot  S 13758-001				Dress, Shirt, Blouse etc. Topstitching (7 mm Left compensating foot)
A C 9	Free presser foot  S 13751-001	 S 13256-001	159288-001	159301-001	Dress, Shirt, Blouse etc. Topstitching (9 mm Right compensating foot)

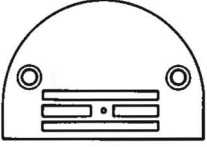
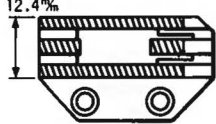
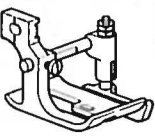

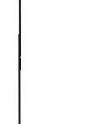
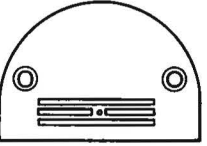
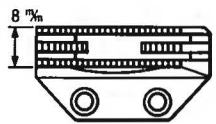
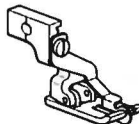

● For Topstitching

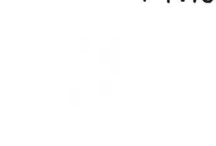
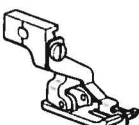
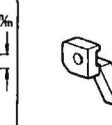
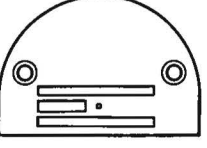
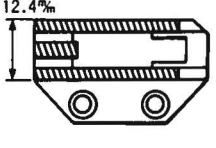
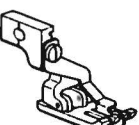
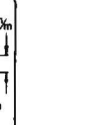
Gauge Type	Presser Foot Assembly	Upper Feed Dog	Needle Plate	Feed Dog	Uses
A M	Free presser foot  159421-101	Oblique type teeth 	$\phi 1.6$ 	Parallel type teeth P 1.15 	Dress, Shirt, Knit-shirt etc. Sewing pocket, Sword polo-stitching, Topstitching front
A S	Free presser foot  154698-101				
A T	Free presser foot  154445-101	 S 13256-001	$\phi 1.2$  159289-001	Oblique type teeth P 1.15 	Lady's wear etc. Stitching sleeve caps of face and lining cloth, Seaming back center, Joining shoulder, Sewing sides
A 22	Whole A Type		$\phi 2.2$  S 13781-001		The needle plate has a bigger needle hole for thick materials
F	Fixed presser foot  151292-201	Cross-shaped type teeth 	$\phi 1.6$ 	Parallel type teeth P 1.15 	Collared shirt etc. Topstitching neck, Stitching cuffs, Side-Pucker Type
F D	Fixed presser foot  153983-101	 S 13260-001			Collared shirt etc. Topstitching neck, Stitching cuffs, Side-Pucker Type (Max stitch width 12 m/m) "FD" is added the thickness presser (183066-001) to "F".

# • For Topstitching

Gauge Type	Presser Foot Assembly	Upper Feed Dog	Needle Plate	Feed Dog	Uses
J	Fixed presser foot  151622-101	Cross-shaped type teeth 	$\phi 1.6$ 	Oblique type teeth P 1.15 	Collared shirt etc. Stitching neck, Stitching cuffs Side · Stretching type
J D	Fixed presser foot  153984-101	 S 13264-001	$\phi 1.6$ 		Collared shirt etc. Stitching neck, Stitching cuffs Side · Stretching type (Max stitch width 12 m/m) "JD" is added the thickness presser (183066-001) to "J".
S	Free presser foot  159443-101	Oblique type teeth 	$\phi 1.6$ 	Parallel type teeth P 1.15 	Shirt, Blouse etc. For small sharp turns
S G 1.5	Free presser foot  S 13761-001		$\phi 1.6$ 	Oblique type teeth P 1.15 	Shirt, Blouse, Dress, Jacket etc. Topstitching edge (With stitch guide spring 1.5 mm)
S G 2	Free presser foot  S 13765-001				Skirt, Slacks, Topstitching belt etc. Various stitching (Stitch width 2 mm)
S G 3	Free presser foot  S 13771-001	 S 13256-001	$\phi 1.6$ 		Skirt, Slacks, Various stitching (With stitch guide spring 3 mm)

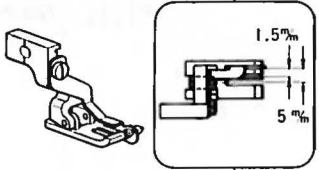
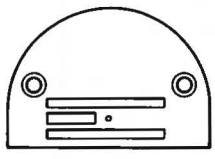
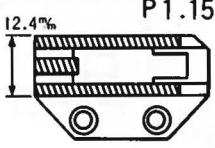
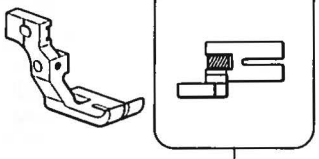
● For Topstitching

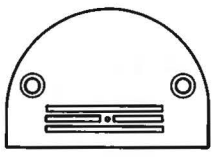
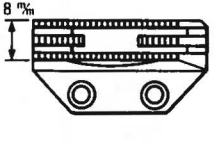
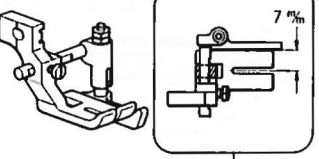
Gauge Type	Presser Foot Assembly	Upper Feed Dog	Needle Plate	Feed Dog	Uses
<p>SG 5</p> <p>Thin·Medium-Thick Materials Exchange parts assembly 183623-101</p>	<p>Free presser foot</p>  <p>S 13769-001</p>	<p>Oblique type teeth</p>	<p>φ 1.6</p>  <p>159292-101</p>	<p>Oblique type teeth P 1.15</p>  <p>S 15074-001</p>	<p>Skirt, Slacks, Topstitching belt etc. Various stitching (Stitch width 5 mm)</p>
<p>SS</p> <p>Thin·Medium-Thick Materials</p>	<p>Fixed presser foot</p>  <p>S 07671-101</p>		<p>φ 1.6</p>  <p>159295-001</p>	<p>Parallel type teeth P 1.15</p>  <p>159305-001</p>	<p>Men's and Lady's wear etc. Stitching sleeve caps, Basting under sleeve, Seaming back center, Joining shoulder, Sewing sides</p>
<p>SSD</p> <p>Thin·Medium-Thick Materials Exchange parts assembly 183590-001</p>	<p>Fixed presser foot</p>  <p>S 07670-101</p>	<p>S 13256-001</p>	<p>159295-001</p>	<p>159305-001</p>	<p>Seaming princesse line, Stitching sleeve caps of double cloth sleeve, Topstitching pocket mouth, Lady's blazer, Men's slacks etc. "SSD" is added the thickness presser (183066-001) to "SS".</p>

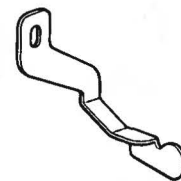
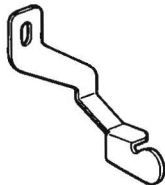

For SG1 .5·2·3 m/m  
For SG4 .5·6 m/m

Guide Plate S13768-001  
Guide Plate S13770-001



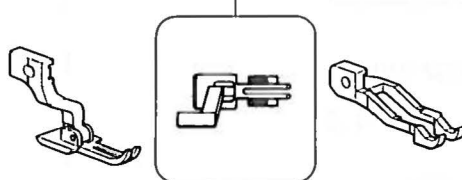
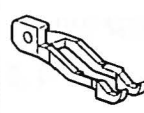
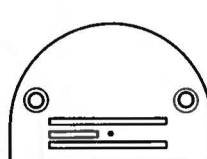
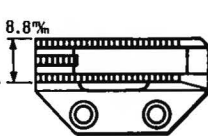
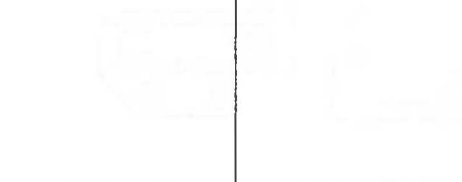

## ● For Gathering

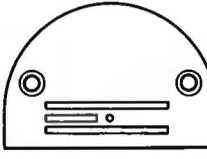
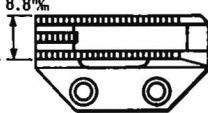
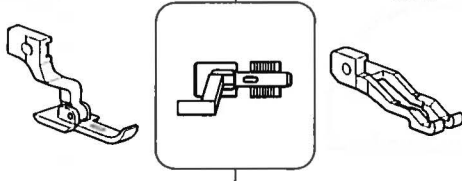
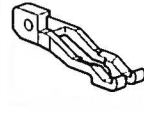
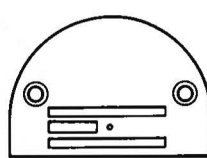
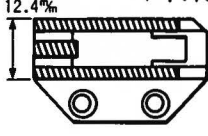
Gauge Type	Presser Foot Assembly	Upper Feed Dog	Needle Plate	Feed Dog	Uses
B	Free presser foot	Cross-chaped type teeth	$\phi 1.6$	Parallel type teeth P 1.15	Attaching yoke, Attaching cuffs, (Gathering) Basting front lining to facing (Effect of uneven material feeding of different materials) Lady's and children's wear etc.
Medium-Thick Materials Exchange parts assembly 183559-101			 S 15094-001	 8.8%	
B22			$\phi 2.2$		The needle plate has a bigger needle hole for thick materials
Thick Materials 183559-001			 S 13782-001	 S 15071-001	
L	Free presser foot	Parallel type teeth	$\phi 1.6$	Oblique type teeth P 1.15	Attaching yoke, Attaching cuffs (Gathering) Basting front lining to facing (Effect of uneven material feeding different materials) Lady's and children's wear etc.
Medium-Thick Materials Exchange parts assembly 183568-101			 159292-101	 12.4%	
	151281-101	S 13257-001	S 13782-001	S 15071-001	
	153575-101	S 13268-001	159292-101	S 15074-001	

Gathering Separator Assembly 183627-001

Separator S3 Assembly 183214-401

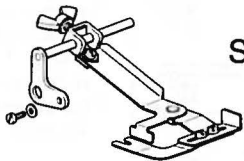

Separator S13369-001

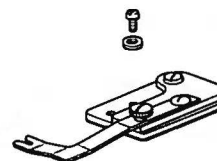

Separator 159321-101



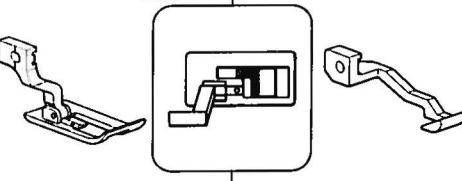
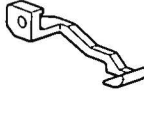
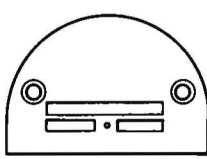
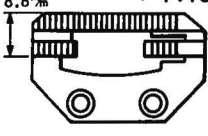
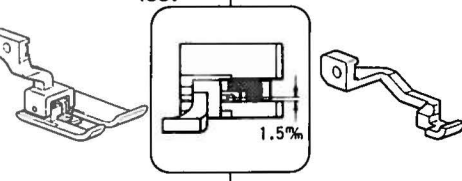
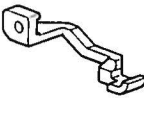
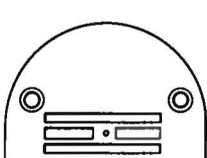
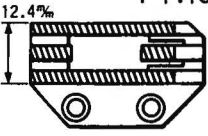



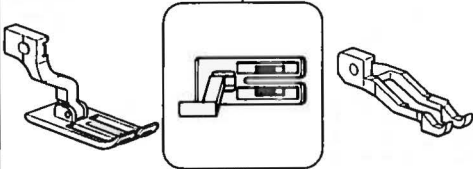
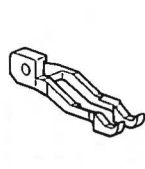
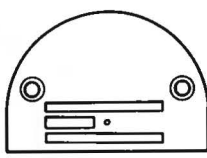
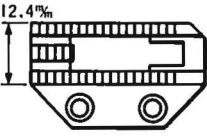
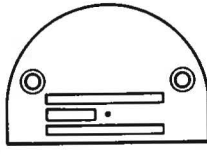
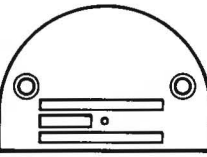
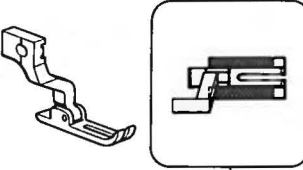
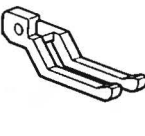
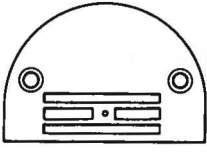
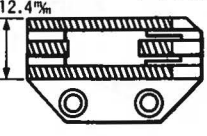

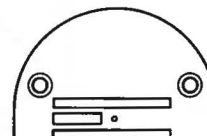
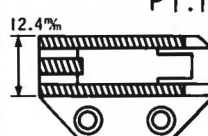

## ● For Rolled-Hemming

Gauge Type	Presser Foot Assembly	Upper Feed Dog	Needle Plate	Feed Dog	Uses
E	Free presser foot	Cross-shaped type teeth	$\phi 1.6$	Parallel type teeth P 1.15	Skirt, One-piece dress etc. For rolled-hemming
Medium-Thick Materials Exchange parts assembly 183562-001			 159294-001	 8.8%	
	151290-101	S 13259-001	159294-001	159304-001	
N	Free presser foot	Cross-shaped type teeth	$\phi 1.6$	Oblique type teeth P 1.15	Dress, Skirt, Coat, One-piece dress etc. For rolled-hemming (Stitch width 1.5 mm Left compensating foot)
Medium-Thick Materials Exchange parts assembly 183582-001			 159288-001	 12.4%	
	S 01658-101	S 13261-001	159288-001	159301-001	

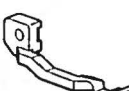
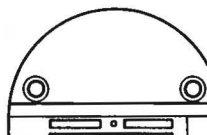
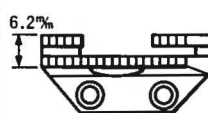
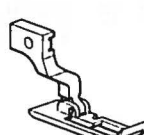
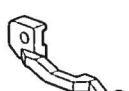
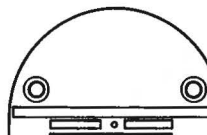
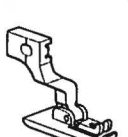
# ● 送りにくい素材用

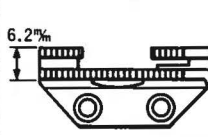
Gauge Type	押 え 組	上 送 り 歯	針 板	送 り 歯	用 途
C	Free presser foot	Cross-shaped type teeth	$\phi 1.6$	Parallel type teeth P 1.6	Seaming princess line, Stitching sleeve caps of double cloth sleeve, Topstitch pocket mouth, Lady's blazer, Men's slacks etc.
Medium-Thick Materials Exchange parts assembly 183560-101			 159292-101		
C 12			 159293-101		
Medium-Thick Materials			 S 13783-001		The needle plate has a bigger needle hole for thick materials
C 22	151286-101	S 13257-001	$\phi 22$	S 15073-001	
Thick Materials					
D	Free presser foot	Cross-shaped type teeth	$\phi 1.6$	Oblique type teeth P 1.15	Ski suit, Leather jumper, Raincoat etc. Sewing under sleeve, Joining shoulder, Sewing sides, Setting sleeves
Thin-Medium-Thick Materials Exchange parts assembly 183561-001			 159288-001	 159301-001	
	151288-101	S 13258-001			

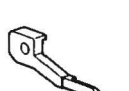
● For Sewing Zipper (Exclusive Right)

Gauge Type	Presser Foot Assembly	Upper Feed Dog	Needle Plate	Feed Dog	Uses
<p>G C</p> <p>Medium-Thick Materials Exchange parts assembly 183625-101</p>	<p>Fixed presser foot</p>  <p>S 13777-001</p>	<p>Cross-shaped type teeth</p>  <p>S 13778-001</p>	<p>φ 1.6</p>  <p>159292-101</p>	<p>Oblique type teeth P 1.15</p>  <p>S 15074-001</p>	<p>Skirt etc. For sewing conceal fastener</p>
<p>G R M</p> <p>Medium-Thick Materials Exchange parts assembly 183576-001</p>	<p>Free presser foot</p>  <p>151293-101</p>	<p>Cross-shaped type teeth</p>  <p>S 13262-001</p>	<p>φ 1.8</p>  <p>159297-001</p>	<p>Parallel type teeth P 1.15</p>  <p>156247-001</p>	<p>One-piece dress, Skirt, Slacks etc. For sewing zipper</p>
<p>G S</p> <p>Medium-Thick Materials Exchange parts assembly 183584-001</p>	<p>Free presser foot</p>  <p>S 04541-001</p>	<p>Cross-shaped type teeth</p>  <p>S 13263-001</p>	<p>φ 1.8</p>  <p>S 04540-001</p>	<p>Parallel type teeth P 1.15</p>	<p>For prevent twisting One-piece dress, Dress, Skirt, Sports-wear etc. For sewing zipper</p>
<p>G R</p> <p>Medium-Thick Materials Exchange parts assembly 183564-001</p>	<p>Free presser foot</p>  <p>151293-101</p>	<p>Cross-shaped type teeth</p>  <p>S 13262-001</p>	<p>φ 1.8</p> 		<p>Skirt, Jumper, One-piece dress, Slacks etc. For sewing zipper</p>
<p>K R</p> <p>Medium-Thick Materials Exchange parts assembly 183577-001</p>	<p>Fixed presser foot</p>  <p>156617-101</p>	<p>Cross-shaped type teeth</p>  <p>S 13267-001</p>	 <p>159296-101</p>	<p>S 00864-001</p>	<p>Sportswear, Ski anorak, Leather Jumper etc. For sewing zipper</p>





● For Sewing Zipper (Exclusive Left)

Gauge Type	Presser Foot Assembly	Upper Feed Dog	Needle Plate	Feed Dog	Uses
G L	Free presser foot	Cross-shaped type teeth	$\phi 1.8$	Parallel type teeth P 1.15	One-piece dress, Skirt etc. For sewing zipper
Medium-Thick Materials Exchange parts assembly 183565-001					
G L M			$\phi 1.8$	Parallel type teeth P 1.6	
Medium-Thick Materials Exchange parts assembly 183146-301	151296-101	S 13261-001	159299-001	159306-001	
K	Fixed presser foot	Free type teeth	$\phi 1.8$	Parallel type teeth P 1.15	Sportswear, Ski anorak, Leather jumper etc. For sewing zipper
Medium-Thick Materials Exchange parts assembly 183567-001					
	153170-101	S 13265-001			
K L 7	Fixed presser foot	Cross-shaped type teeth			School trousers etc. For sewing zipper
Medium-Thick Materials Exchange parts assembly 183583-001					
	S 01941-101	S 13266-001	159298-101	S 00865-001	

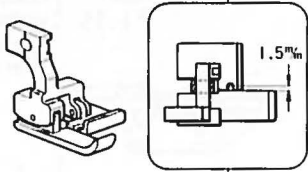

● For Binding

Gauge Type	Presser Foot Assembly	Upper Feed Dog	Needle Plate	Feed Dog	Uses
H	Free presser foot	Oblique type teeth			Dress, One-piece dress, Coat, Blazer, Best etc. For binding
Medium-Thick Materials					
	151299-101	S 13256-001	Goods on the market	Goods on the market	

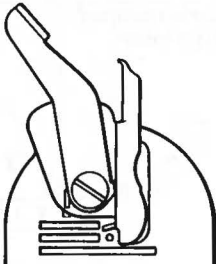
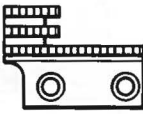
## ● For Binding

Gauge Type	Presser Foot Assembly	Upper Feed Dog	Needle Plate	Feed Dog	Uses
HC	Free presser foot	Oblique type teeth			One-piece dress, Jacket, Best, Dress etc. For binding
Medium-Thick Materials	 S 14315-001	 S 13256-001	 Goods on the market	 Goods on the market	

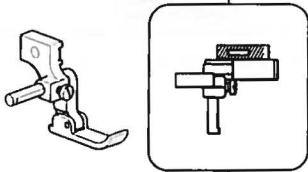

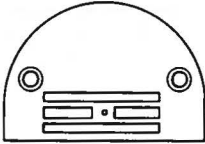
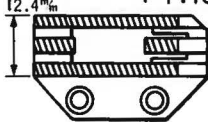
## ● For Restrain Cloth From Flapping

Gauge Type	Presser Foot Assembly	Upper Feed Dog	Needle Plate	Feed Dog	Uses
M	Free presser foot	Oblique type teeth	$\phi 1.6$	Oblique type teeth P 1.15	Skirt, One-piece dress, Jumper etc. For sewing zipper Stitching-Topstitching edge
Medium-Thick Materials Exchange parts assembly 183569-001	 153978-101	 S 13269-001	 159288-001	 159301-001	

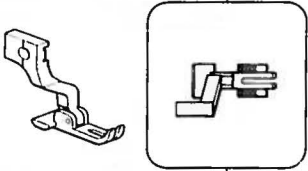
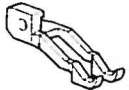
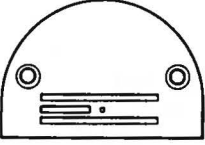
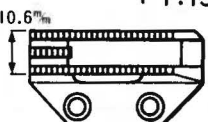
## ● Effective Type For Packer

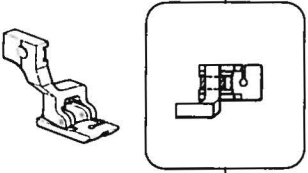

Gauge Type	Presser Foot Assembly	Upper Feed Dog	Needle Plate	Feed Dog	Uses
P	Free presser foot	Cross-shaped type teeth	$\phi 1.6$	Parallel type teeth P 1.15	Lady's wear, Flimsy dress, Blouse etc. This type possesses middle peculiarity of pucker and stretching.
Thin Materials Exchange parts assembly 183585-101	 S 04550-101	 S 13270-001	 S 13398-001	 S 13364-001	

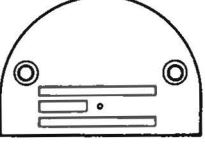
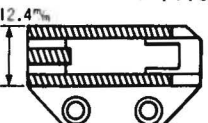
## ● For Piping

Gauge Type	Presser Foot Assembly	Upper Feed Dog	Needle Plate	Feed Dog	Uses
SP	Free presser foot	Oblique type teeth	$\phi 1.6$	Oblique type teeth P 1.15	Dress, One-piece dress, Cort, Blazer etc. For piping
Thin-Medium-Thick Materials Exchange parts assembly 183624-101	 S 13774-001	 S 15093-001	 159292-101	 S 15074-001	



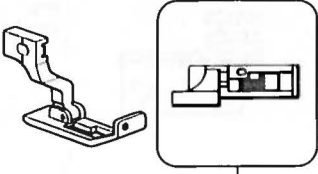
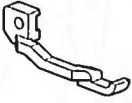
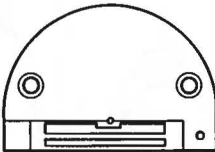
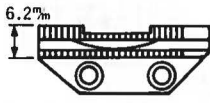
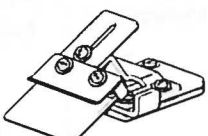
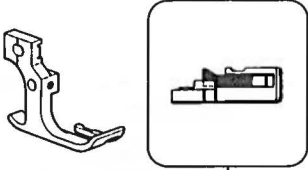
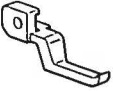

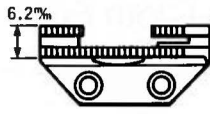
## ● For Concealed-Seaming Waist Belt

Gauge Type	Presser Foot Assembly	Upper Feed Dog	Needle Plate	Feed Dog	Uses
<b>WB</b>  Thin·Medium-Thick Materials WB Device Complete 183553-001	Free presser foot   S 01258-101	Cross-shaped type teeth   S 13271-001	$\phi 1.8$   S 01256-001	Parallel type teeth P 1.15   S 01261-001	Slacks, Skirt, For concealed-seaming waist belt Conceal from seamy side type  
<b>WJ</b>  Thin·Medium-Thick Materials Exchange parts assembly 183626-001	Fixed presser foot   S 13779-001	Cross-shaped type teeth   S 13780-001	$\phi 1.8$   159296-101	Parallel type teeth P 1.15   S 00864-001	This type is one, brought needle location close to inside belt.

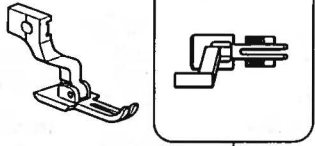
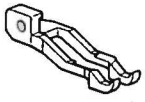
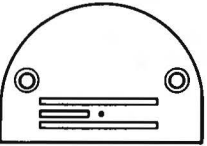
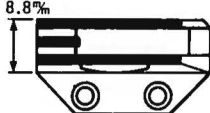
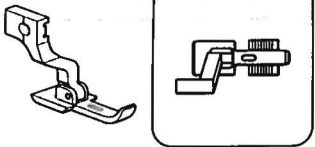
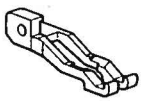
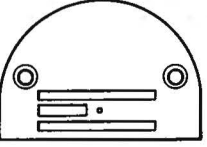
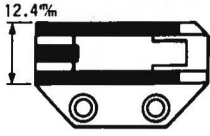
## ● Special Type

Gauge Type	Presser Foot Assembly	Upper Feed Dog	Needle Plate	Feed Dog	Uses
<b>BT</b>  Thin Materials Exchange parts assembly 183574-101	Free presser foot   151281-101	Cross-shaped type teeth   S 13257-001	$\phi 1.2$   159291-101	Rubber feed dog   S 15072-001	Quilt materials, Nylon, Taffeta, Lining cloth, Lady's thin materials etc. For prevent to make cloth cut, this type is added urethane to "159302-001".
<b>LT</b>  Thin Materials Exchange parts assembly 183575-101	Free presser foot   153575-101	Parallel type teeth   S 13268-001	$\phi 1.6$   159292-101	Rubber feed dog   S 15075-001	Quilt materials, Nylon, Taffeta, Lining cloth, Lady's thin materials etc. For prevent to make cloth cut, this type is added urethane to "159307-001".

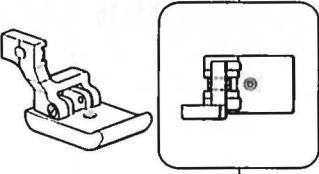
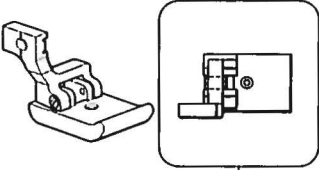
## ● Special Type

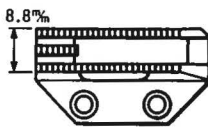
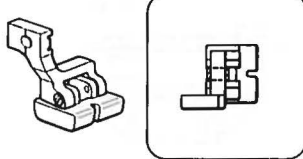
Gauge Type	Presser Foot Assembly	Upper Feed Dog	Needle Plate	Feed Dog	Uses
T	Free presser foot  S 04554-101	Oblique type teeth	$\phi 1.6$	Oblique type teeth P 1.15	Men's wear, Lady's wear etc. Stitching sleeve caps, Sewing under sleeve, Seaming under sleeve, Seaming back center, Joining shoulder, Effective for materials difficult to slide Teflon presser
TL	Free presser foot  S 07035-101			 8.8%	Topstitching edge, Transparent presser foot for piping
TP	Free presser foot  S 07196-101	S 13256-001	S 15094-001	S 15071-001	Transparent presser foot for pin tack

## ● For B7740, 25 m/m Sensor

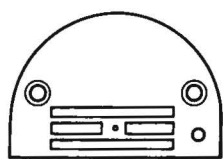
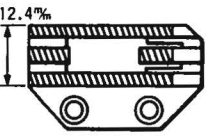
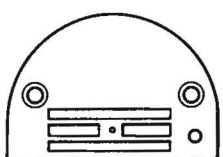
Gauge Type	Presser Foot Assembly	Upper Feed Dog	Needle Plate	Feed Dog	Uses
A 12S	Whole A Type		$\phi 1.2$  S 13357-001	 12.4%	
A 16S			$\phi 1.6$  S 13356-001		

● For B7740, 25 m/m Sensor

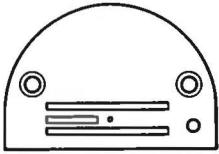
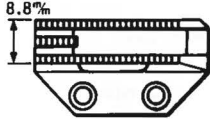
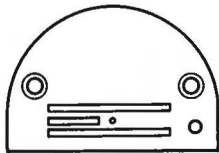
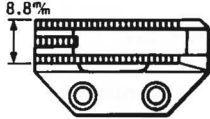
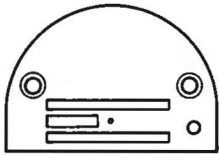
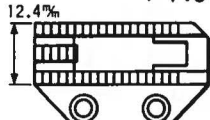
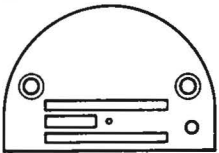
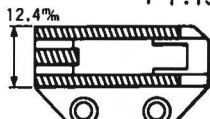
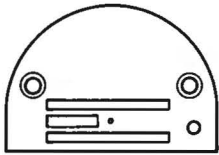
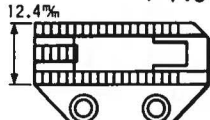
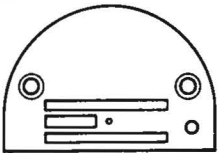
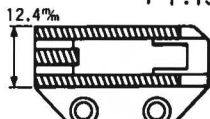
Gauge Type	Presser Foot Assembly	Upper Feed Dog	Needle Plate	Feed Dog	Uses
B 12S	Whole B·P Type		$\phi 1.2$  S 13359-101	Parallel type teeth P 1.15  	
B 16S			$\phi 1.6$  S 13358-101	 S 15071-001	
C 12S	Whole C·SG Type		$\phi 1.6$  S 13361-101	Parallel type teeth P 1.6   S 15073-001	
C 16S			$\phi 1.6$  S 13360-101	Oblique type teeth P 1.15   S 15074-001	
C 12S	Whole C·SG Type		$\phi 1.6$  S 13361-101	Parallel type teeth P 1.6   S 15073-001	
C 16S			$\phi 1.6$  S 13360-101	Oblique type teeth P 1.15   S 15074-001	

● For B7740, 25 m/m Sensor

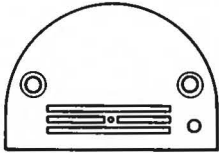
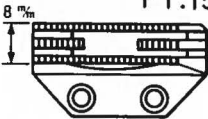
Gauge Type	Presser Foot Assembly	Upper Feed Dog	Needle Plate	Feed Dog	Uses
F 16 S	Whole F · S · SS Type		$\phi 1.6$  S 13362-001	Parallel type teeth P 1.15  8 mm 159305-001	

● For B7740, 18 m/m Sensor  
(Please use it when stitch length is less than 4 mm)

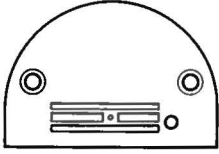
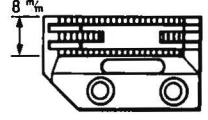
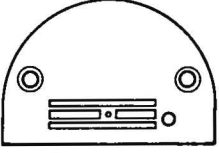
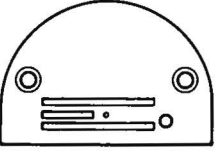
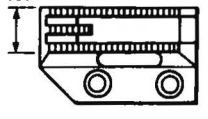
Gauge Type	Presser Foot Assembly	Upper Feed Dog	Needle Plate	Feed Dog	Uses
AB 14 T	Whole A · F · S Type		$\phi 1.4$  S 07037-001	Parallel type teeth P 1.15  8 mm	
AB 16 T			$\phi 1.6$  S 06654-001		
P 16 T	Whole B · P Type		$\phi 1.6$  S 13363-001	Parallel type teeth P 1.15  10.6 mm S 13364-001	

		<p><i>(Faint text describing the drawings)</i></p>
---	---	--

*(Faint text, possibly a title or description)*





117-773-774-7740  
195774-112  
1990.01

BROTHER INDUSTRIES, LTD. NAGOYA, JAPAN

From the library of: Superior Sewing Machine & Supply LLC

Printed in Japan